

MM74HC14 Hex Inverting Schmitt Trigger

General Description

The MM74HC14 utilizes advanced silicon-gate CMOS technology to achieve the low power dissipation and high noise immunity of standard CMOS, as well as the capability to drive 10 LS-TTL loads.

The 74HC logic family is functionally and pinout compatible with the standard 74LS logic family. All inputs are protected from damage due to static discharge by internal diode clamps to V_{CC} and ground.

Features

- Typical propagation delay: 13 ns
- Wide power supply range: 2–6V
- Low quiescent current: 20 μ A maximum (74HC Series)
- Low input current: 1 μ A maximum
- Fanout of 10 LS-TTL loads
- Typical hysteresis voltage: 0.9V at $V_{CC} = 4.5V$

Ordering Code:

Order Number	Package Number	Package Description
MM74HC14M	M14A	14-Lead Small Outline Integrated Circuit (SOIC), JEDEC MS-120, 0.150" Narrow
MM74HC14SJ	M14D	14-Lead Small Outline Package (SOP), EIAJ TYPE II, 5.3mm Wide
MM74HC14MTC	MTC14	14-Lead Thin Shrink Small Outline Package (TSSOP), JEDEC MO-153, 4.4mm Wide
MM74HC14N	N14A	14-Lead Plastic Dual-In-Line Package (PDIP), JEDEC MS-001, 0.300" Wide

Devices also available in Tape and Reel. Specify by appending the suffix letter "X" to the ordering code.

Connection Diagram

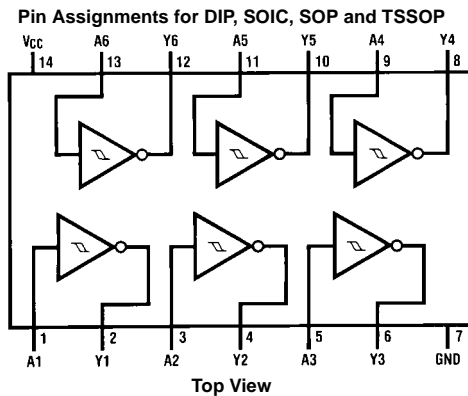

Logic Diagram

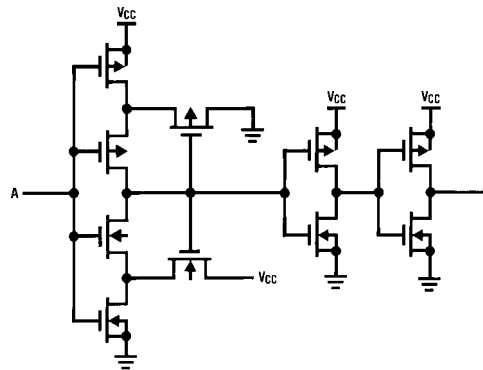

Absolute Maximum Ratings (Note 1)

(Note 2)

Supply Voltage (V_{CC})	-0.5 to +7.0V
DC Input Voltage (V_{IN})	-1.5 to $V_{CC} + 1.5V$
DC Output Voltage (V_{OUT})	-0.5 to $V_{CC} + 0.5V$
Clamp Diode Current (I_{IK}, I_{OK})	± 20 mA
DC Output Current, per pin (I_{OUT})	± 25 mA
DC V_{CC} or GND Current, per pin (I_{CC})	± 50 mA
Storage Temperature Range (T_{STG})	-65°C to +150°C
Power Dissipation (P_D)	
(Note 3)	600 mW
S.O. Package only	500 mW
Lead Temperature (T_L)	
(Soldering 10 seconds)	260°C

Recommended Operating Conditions

	Min	Max	Units
Supply Voltage (V_{CC})	2	6	V
DC Input or Output Voltage (V_{IN}, V_{OUT})	0	V_{CC}	V
Operating Temperature Range (T_A)	-40	+85	°C

Note 1: Absolute Maximum Ratings are those values beyond which damage to the device may occur.**Note 2:** Unless otherwise specified all voltages are referenced to ground.**Note 3:** Power Dissipation temperature derating — plastic "N" package: -12 mW/°C from 65°C to 85°C.**DC Electrical Characteristics** (Note 4)

Symbol	Parameter	Conditions	V_{CC}	$T_A = 25^\circ\text{C}$		$T_A = -40 \text{ to } 85^\circ\text{C}$		$T_A = -55 \text{ to } 125^\circ\text{C}$		Units
				Typ	Guaranteed Limits					
V_{T+}	Positive Going Threshold Voltage	Minimum	2.0V	1.2	1.0	1.0	1.0	V		
			4.5V	2.7	2.0	2.0	2.0	V		
			6.0V	3.2	3.0	3.0	3.0	V		
		Maximum	2.0V	1.2	1.5	1.5	1.5	V		
			4.5V	2.7	3.15	3.15	3.15	V		
			6.0V	3.2	4.2	4.2	4.2	V		
V_{T-}	Negative Going Threshold Voltage	Minimum	2.0V	0.7	0.3	0.3	0.3	V		
			4.5V	1.8	0.9	0.9	0.9	V		
			6.0V	2.2	1.2	1.2	1.2	V		
		Maximum	2.0V	0.7	1.0	1.0	1.0	V		
			4.5V	1.8	2.2	2.2	2.2	V		
			6.0V	2.2	3.0	3.0	3.0	V		
V_H	Hysteresis Voltage	Minimum	2.0V	0.5	0.2	0.2	0.2	V		
			4.5V	0.9	0.4	0.4	0.4	V		
			6.0V	1.0	0.5	0.5	0.5	V		
		Maximum	2.0V	0.5	1.0	1.0	1.0	V		
			4.5V	0.9	1.4	1.4	1.4	V		
			6.0V	1.0	1.5	1.5	1.5	V		
V_{OH}	Minimum HIGH Level Output Voltage	$V_{IN} = V_{IL}$ $ I_{OUT} = 20 \mu\text{A}$	2.0V	2.0	1.9	1.9	1.9	V		
			4.5V	4.5	4.4	4.4	4.4	V		
			6.0V	6.0	5.9	5.9	5.9	V		
		$V_{IN} = V_{IL}$ $ I_{OUT} = 4.0 \text{ mA}$ $ I_{OUT} = 5.2 \text{ mA}$	4.5V	4.2	3.98	3.84	3.7	V		
			6.0V	5.7	5.48	5.34	5.2	V		
V_{OL}	Maximum LOW Level Output Voltage	$V_{IN} = V_{IH}$ $ I_{OUT} = 20 \mu\text{A}$	2.0V	0	0.1	0.1	0.1	V		
			4.5V	0	0.1	0.1	0.1	V		
			6.0V	0	0.1	0.1	0.1	V		
		$V_{IN} = V_{IH}$ $ I_{OUT} = 4.0 \text{ mA}$ $ I_{OUT} = 5.2 \text{ mA}$	4.5V	0.2	0.26	0.33	0.4	V		
			6.0V	0.2	0.26	0.33	0.4	V		
I_{IN}	Maximum Input Current	$V_{IN} = V_{CC}$ or GND	6.0V		± 0.1	± 1.0	± 1.0	μA		
I_{CC}	Maximum Quiescent Supply Current	$V_{IN} = V_{CC}$ or GND $I_{OUT} = 0 \mu\text{A}$	6.0V		2.0	20	40	μA		

Note 4: For a power supply of 5V $\pm 10\%$ the worst case output voltages (V_{OH} and V_{OL}) occur for HC at 4.5V. Thus the 4.5V values should be used when designing with this supply. Worst case V_{IH} and V_{IL} occur at $V_{CC} = 5.5V$ and 4.5V respectively. (The V_{IH} value at 5.5V is 3.85V.) The worst case leakage current (I_{IN} , I_{CC} , and I_{OZ}) occur for CMOS at the higher voltage and so the 6.0V values should be used.

AC Electrical Characteristics

$V_{CC} = 5V, T_A = 25^\circ C, C_L = 15 \text{ pF}, t_r = t_f = 6 \text{ ns}$

Symbol	Parameter	Conditions	Typ	Guaranteed Limit	Units
t_{PHL}, t_{PLH}	Maximum Propagation Delay		12	22	ns

AC Electrical Characteristics

$V_{CC} = 2.0V \text{ to } 6.0V, C_L = 50 \text{ pF}, t_r = t_f = 6 \text{ ns}$ (unless otherwise specified)

Symbol	Parameter	Conditions	V_{CC}	$T_A = 25^\circ C$		$T_A = -40 \text{ to } 85^\circ C$	$T_A = -55 \text{ to } 125^\circ C$	Units
				Typ	Guaranteed Limits			
t_{PHL}, t_{PLH}	Maximum Propagation Delay		2.0V	60	125	156	188	ns
			4.5V	13	25	31	38	ns
			6.0V	11	21	26	32	ns
t_{TLH}, t_{THL}	Maximum Output Rise and Fall Time		2.0V	30	75	95	110	ns
			4.5V	8	15	19	22	ns
			6.0V	7	13	16	19	ns
C_{PD}	Power Dissipation Capacitance (Note 5)	(per gate)		27				pF
C_{IN}	Maximum Input Capacitance			5	10	10	10	pF

Note 5: C_{PD} determines the no load dynamic power consumption, $P_D = C_{PD} V_{CC}^2 f + I_{CC} V_{CC}$, and the no load dynamic current consumption, $I_S = C_{PD} V_{CC} f + I_{CC}$.

Typical Performance Characteristics

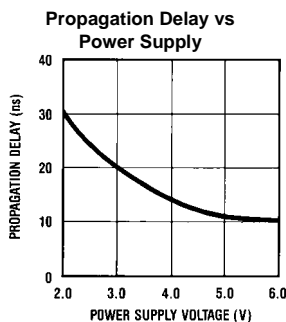
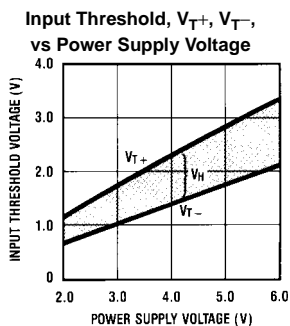

Typical Applications

Low Power Oscillator

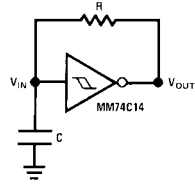

$$t_1 \approx RC \ln \frac{V_{T+}}{V_{T-}}$$

$$t_2 \approx RC \ln \frac{V_{CC} - V_{T-}}{V_{CC} - V_{T+}}$$

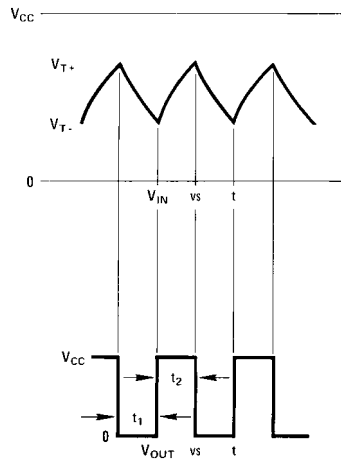

$$f \approx \frac{1}{RC \ln \frac{V_{T+}(V_{CC} - V_{T-})}{V_{T-}(V_{CC} - V_{T+})}}$$

Note: The equations assume $t_1 + t_2 \gg t_{pd0} + t_{pd1}$

Physical Dimensions inches (millimeters) unless otherwise noted

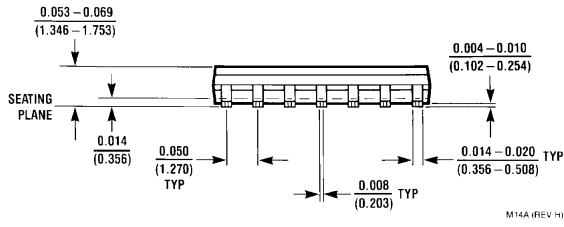
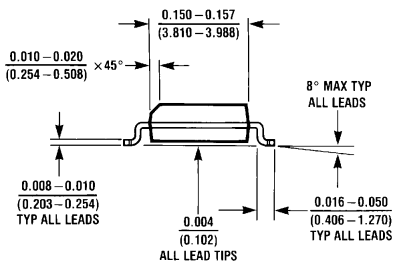
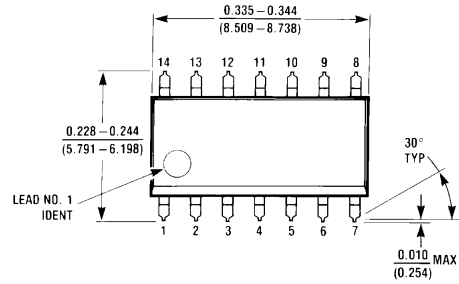

M14A (REV H)

**14-Lead Small Outline Integrated Circuit (SOIC), JEDEC MS-120, 0.150" Narrow
Package Number M14A**

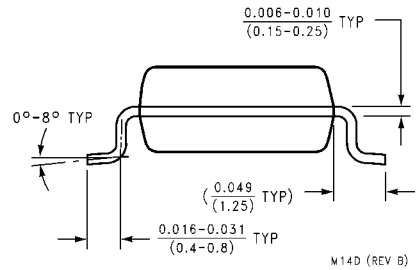
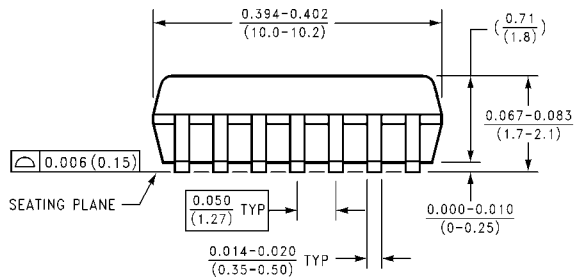
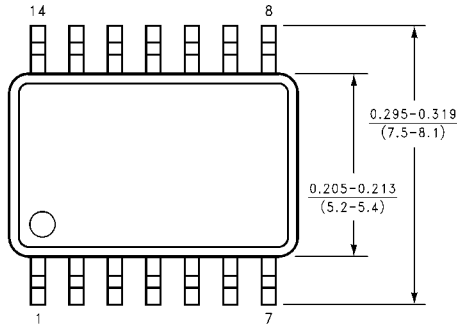

M14D (REV B)

**14-Lead Small Outline Package (SOP), EIAJ TYPE II, 5.3mm Wide
Package Number M14D**

Physical Dimensions inches (millimeters) unless otherwise noted (Continued)

14LD, TSSOP, JEDEC MO-153, 4.4MM WIDE

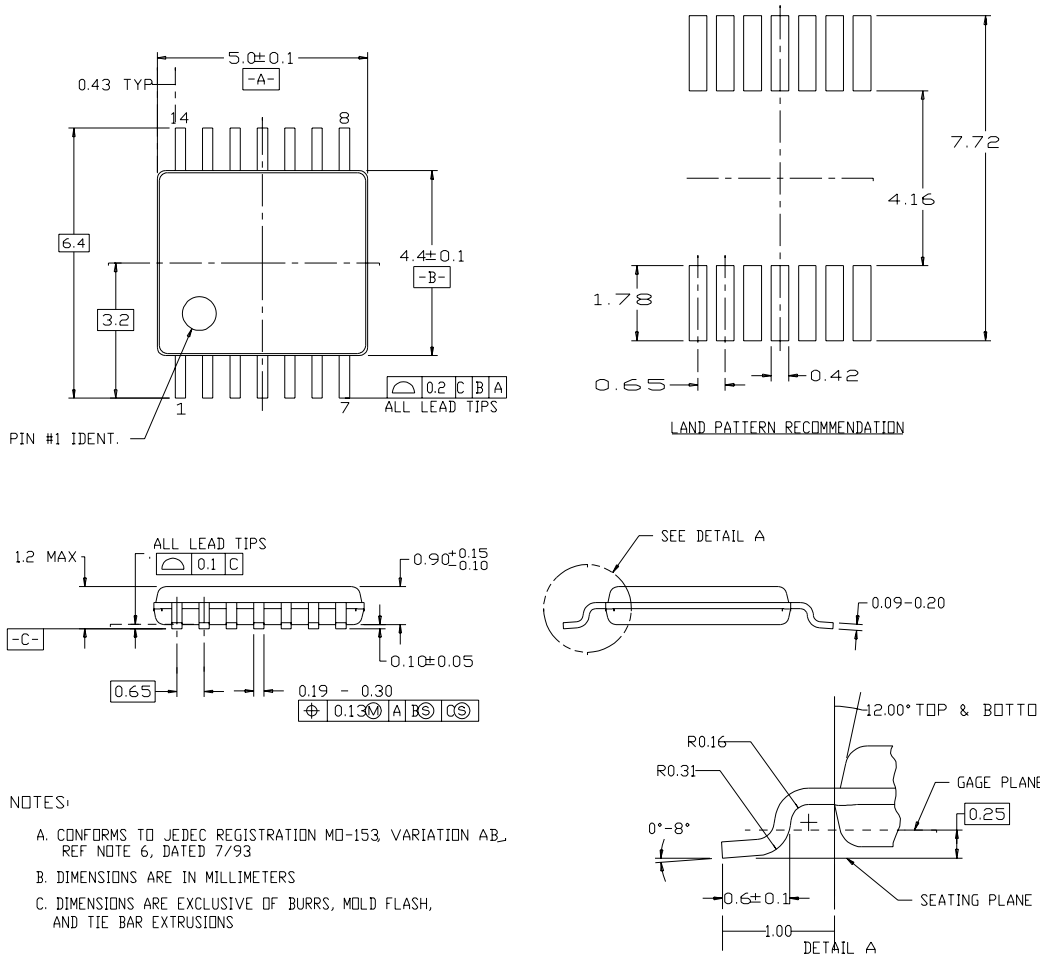

NOTES:

- A. CONFORMS TO JEDEC REGISTRATION MO-153, VARIATION AB, REF NOTE 6, DATED 7/93
- B. DIMENSIONS ARE IN MILLIMETERS
- C. DIMENSIONS ARE EXCLUSIVE OF BURRS, MOLD FLASH, AND TIE BAR EXTRUSIONS

14-Lead Thin Shrink Small Outline Package (TSSOP), JEDEC MO-153, 4.4mm Wide Package Number MTC14

Physical Dimensions inches (millimeters) unless otherwise noted (Continued)

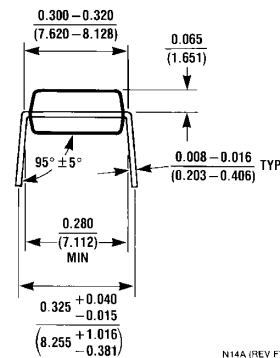
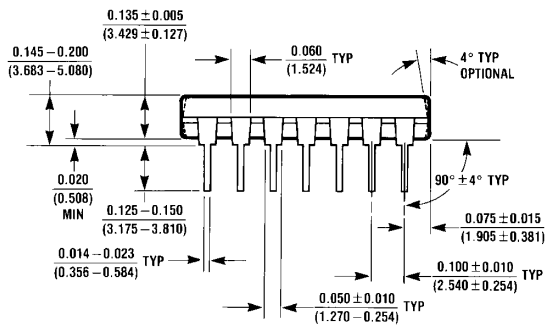
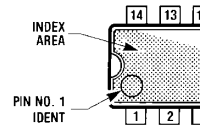
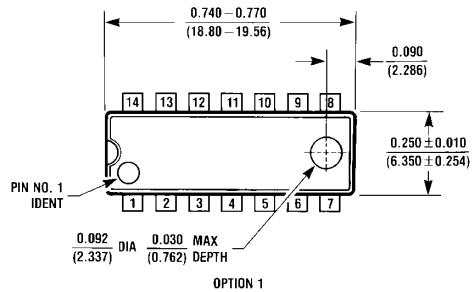

N14A (REV F)

14-Lead Plastic Dual-In-Line Package (PDIP), JEDEC MS-001, 0.300" Wide Package Number N14A

LIFE SUPPORT POLICY

FAIRCHILD'S PRODUCTS ARE NOT AUTHORIZED FOR USE AS CRITICAL COMPONENTS IN LIFE SUPPORT DEVICES OR SYSTEMS WITHOUT THE EXPRESS WRITTEN APPROVAL OF THE PRESIDENT OF FAIRCHILD SEMICONDUCTOR CORPORATION. As used herein:

1. Life support devices or systems are devices or systems which, (a) are intended for surgical implant into the body, or (b) support or sustain life, and (c) whose failure to perform when properly used in accordance with instructions for use provided in the labeling, can be reasonably expected to result in a significant injury to the user.
2. A critical component in any component of a life support device or system whose failure to perform can be reasonably expected to cause the failure of the life support device or system, or to affect its safety or effectiveness.

www.fairchildsemi.com